

KENWOOD

PORTABLE COMPACT DISC PLAYER

DPC-721

DPC-521

DPC-321

INSTRUCTION MANUAL

KENWOOD CORPORATION

Notes:

This instruction manual is for common use with the three models above.

COMPACT
disc
DIGITAL AUDIO

B60-0813-40 (JA) (K P E T M Y) A
93/2 1 92/12 11

Introduction

Your choice of this product indicates that you are a devotee to excellence in sound reproduction. We appreciate your patronage and take pride in the long tradition of quality components that our company represents.

So that you can get the most out of your unit, we suggest that you take the time to read through this manual before you hook up and operate your system. This will acquaint you with operating features and system-connection considerations so that your listening pleasure will be enhanced right from the start. You will notice that in all aspects of planning, engineering, styling, operating convenience and adaptability we have sought to anticipate your needs and desires.

Keep this manual handy for future reference.

For your records

Record the serial number, found on the back of the unit, in the spaces designated on the warranty card, and in the space provided below. Refer to the model and serial numbers whenever you call upon your dealer for information or service on this product.



Model _____ Serial Number _____

Unpacking

Unpack the unit carefully and make sure that all accessories are put aside so they will not be lost. Examine the unit for any possibility of shipping damage. If your unit is damaged or fails to operate, notify your dealer immediately. If your unit was shipped to you directly, notify the shipping company without delay. Only the consignee (the person or company receiving the unit) can file a claim against the carrier for shipping damage. We recommend that you retain the original carton and packing materials for use should you transport or ship the unit in the future.

Contents

Caution: Read the pages marked  carefully to ensure safe operation.

Introduction	2	Special playback operations	18
 Before applying power	4	AI TIMER operations	19
 Safety precautions	4	AI TIMER playback procedure	20
 IMPORTANT SAFEGUARDS	5	AI Sound processor	22
Power supplies	8	HOLD/RESUME switch	23
Controls and indicators	10	Listening through car stereo	24
Preparation for playback	12	Listening through audio system	25
Basic operation	13	In case of difficulty	26
Starting playback from the desired track	15	Specifications	27
Programmed playback	16		

■ Accessories

Check that all of the following accessories are present in the package.

Common accessories to DPC-721, DPC-521 and DPC-321

- AC adapter 1
(The design varies depending on the destination areas.)
- Rechargeable battery 2
- Audio cord 1

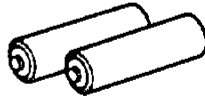
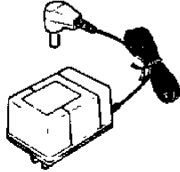

- Open-air headphones 1
(Except for some areas)
- Carrying case 1
(Except for some areas)

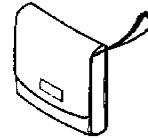

Common accessories to DPC-721 and DPC-521

- Card remote control unit 1
- Car cassette adapter 1
(Except for some areas)



- Car battery adapter 1
(Except for some areas)
- Accessory of DPC-721 alone**
- LCD display remote control unit 1



Common accessory to DPC-721 and DPC-321

- Micro-headphones 1
(Except for some areas)
- Accessory of DPC-321 alone
(For the U.S.A. only)**
- Micro-headphones with remote controller 1

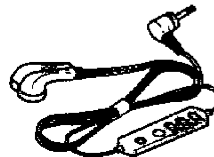

Before applying power

⚠ Caution: Read this page carefully to ensure safe operation.

For the U.S.A. and Canada

Important!

Units shipped to the U.S.A. and Canada are designed for operation on 120 volts AC only.

CAUTION: TO PREVENT ELECTRIC SHOCK DO NOT USE THE AC PLUG WITH AN EXTENSION CORD, RECEPTACLE OR OTHER OUTLET UNLESS THE BLADES CAN BE FULLY INSERTED TO PREVENT BLADE EXPOSURE.

For the United Kingdom

Important!

Units shipped to the U.K. are designed for operation on 240 volts AC only.

The mains plug must be removed from the wall socket prior to any internal examination.

The wires in this mains lead are coloured in accordance with the following code:

Blue Neutral
Brown Live

The wires in this mains lead must be connected to the terminals in the plug as follows:

Wire colour	Plug terminal marking
Blue Neutral	N or Black
Brown Live	L or Red

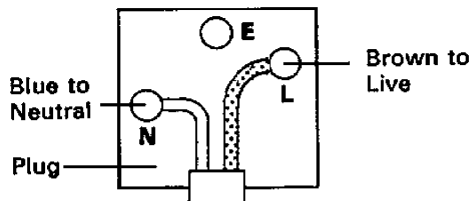

Notes:

1. If a 13-amp plug is used, this must be fitted with a 5-amp fuse.
2. If a 3-pin plug with earthing contact is used, no wire must be connected to the E terminal.

For Europe

Important!

Units shipped to Europe are designed for operation on 230 V AC only.

For other countries

Important!

AC adaptor shipped to countries other than the above are equipped with an AC voltage selector switch on the bottom cover. Refer to the following paragraph for the proper setting of this switch.

AC voltage selection

AC adaptor operates on 110 ~ 120 volts or 220 ~ 240 volts AC. Before connecting the power cord to your AC outlet, make sure that the setting position of this switch matches your line voltage. If not, it must be set to your voltage in accordance with the following direction.

Note:

Our warranty does not cover damage caused by excessive line voltage due to improper setting of the AC voltage selector switch.



110 V - 120 V

220 V - 240 V

The AC adaptor is provided with a voltage selector switch which has been preset for 220 - 240 V.

If using it with 110 - 120 V power, set the switch to the 110 - 120 V position.

AC voltage selector switch

Fig. 1

Safety precautions

WARNING: TO PREVENT FIRE OR ELECTRIC SHOCK, DO NOT EXPOSE THIS APPLIANCE TO RAIN OR MOISTURE.

The marking of products using lasers (Except for some areas).

**CLASS 1
LASER PRODUCT**

This label is attached to the bottom panel and says that the component uses laser beams that have been classified as Class 1. It means that the unit is utilizing laser beams that are of a weaker class. There is no danger of hazardous radiation outside the unit.

WARNING NOTICE:

IN MOST CASES IT IS AN INFRINGEMENT OF COPYRIGHT TO MAKE COPIES OF TAPES OR DISCS WITHOUT THE PERMISSION OF THE COPYRIGHT OWNERS. ANYONE WISHING TO COPY COMMERCIALY AVAILABLE TAPES OR DISCS SHOULD CONTACT THE MECHANICAL COPYRIGHT PROTECTION SOCIETY LIMITED OR THE PERFORMING RIGHTS SOCIETY LIMITED.

IMPORTANT SAFEGUARDS

⚠ Caution: Read this page carefully to ensure safe operation.

Please read all of the safety and operating instructions before operating this unit. For best results, follow all warnings placed on the unit and adhere to the operating and use instructions. These safety and operating instructions should be retained for future reference.

- 1. Power sources** — The unit should be connected to a power supply only of the type described in the operating instructions or as marked on the appliance.
- 2. Power-cord protection** — Power-supply cords should be routed so that they are not likely to be walked on or pinched by items placed upon or against them, pay particular attention to cords at plugs, convenience receptacles, and the point where they exit from the unit.
- 3. Enclosure removal** — Never remove the enclosure. If the internal parts are touched accidentally, a serious electric shock might occur.
- 4. Drop** — Do not drop the unit or apply strong shock to it. (Damage due to dropping the unit is not covered by the warranty.)
- 5. Ventilation** — Avoid hindering the ventilation of the unit by covering it with a cloth, etc.
- 6. Abnormal smell** — If an abnormal smell or smoke is detected, immediately turn the power OFF and pull out the power cord. Contact your dealer or nearest service center.
- 7. Heat** — Avoid placing the unit under direct sunlight or near a source of heat such as heating equipment. Particularly, never leave it in an automobile or on the dashboard.
- 8. Temperature** — The unit may not function properly if used at extremely low, or freezing temperatures. The ideal ambient temperature is above + 5°C (41°F).
- 9. Water and moisture** — The unit should not be used near water — for example, near a bathtub, washbowl, kitchen sink, laundry tub, in a wet basement, or near a swimming pool, etc.
- 10. Dust and moisture** — Avoid places where is dusty or where the humidity is high.
- 11. Vibrations** — Avoid placing the unit on an unstable place such as a shelf or in a place subject to vibrations.
- 12. Magnetic fields** — Keep the unit away from sources of magnetic fields such as TV sets, speaker systems, radios, motorized toys or magnetized objects.
- 13. Cleaning** — Do not use volatile solvents such as alcohol, paint thinner, gasoline, or benzine, etc. to clean the cabinet. Use a clean dry cloth.
- 14. Nonuse periods** — The power cord of the unit should be unplugged from the outlet when left unused for a long period of time.
- 15. Damage requiring service** — The unit should be serviced by qualified service personnel when:
 - A.** The power-supply cord or the plug has been damaged; or
 - B.** Objects have fallen, or liquid has been spilled into the unit; or
 - C.** The unit has been exposed to rain; or
 - D.** The unit does not appear to operate normally or exhibits a marked change in performance; or
 - E.** The unit has been dropped, or the enclosure damaged.
- 16. Servicing** — The user should not attempt to service the unit beyond that described in the operating instructions. All other servicing should be referred to qualified service personnel.

In case of abnormality, immediately press the open key to turn the power OFF, and unplug the AC adapter from the power outlet. Then please contact your nearest KENWOOD service center.

Disc handling precautions

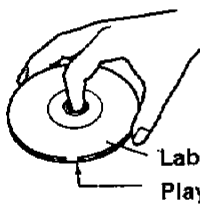

Handling

Hold compact discs so that you do not touch the playing surface.

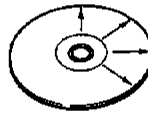

Cleaning

If fingerprints or foreign matter become attached to the disc, lightly wipe the disc with a soft cotton cloth (or similar) from the center of the disc outwards in a radial manner.



Do not attach paper or tape to either the playing side or the label side of compact discs.

Storage

When a disc is not to be played for a long period of time, remove it from the CD player and store it in its case.

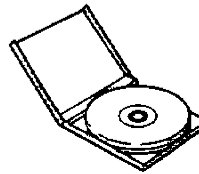

Caution on disc used



Never play a cracked or warped disc.

During playback, the disc rotates at high speed in the player. Therefore, to avoid danger, never use a cracked or deformed disc or a disc repaired with tape or adhesive agent.

8 cm single CD

- This unit can play 8 cm single CD directly, without the help of an adapter. (Do not use single CD adapter sold in audio or record stores, for this may lead to malfunction.)

Condensation

- Immediately after a heater is turned or when the unit is used in a room with high steam content or moisture, dew may be condensed on the lens inside the unit, causing malfunction. In this case, press the  (OFF) key twice to turn power OFF (pressing the key only once is not enough, because it simply enters the stop mode), leave the unit for about an hour, then place a disc and start playback.



Dear Customer:

Selecting fine audio equipment such as the unit you've just purchased is only the start of your musical enjoyment. Now it's time to consider how you can maximize the fun and excitement your equipment offers. This manufacturer and the Electronic Industries Association's Consumer Electronics Group want you to get the most out of your equipment by playing it at a safe level. One that lets the sound come through loud and clear without annoying blaring or distortion — and, most importantly, without affecting your sensitive hearing.

Sound can be deceiving. Over time your hearing "comfort level" adapts to higher volumes of sound. So what sounds "normal" can actually be loud and harmful to your hearing. Guard against this by setting your equipment at a safe level BEFORE your hearing adapts.

To establish a safe level:

- Start your volume control at a low setting.
- Slowly increase the sound until you can hear it comfortably and clearly, and without distortion.

Once you have established a comfortable sound level:

- Set the dial and leave it there.

Taking a minute to do this now will help to prevent hearing damage or loss in the future. After all, we want you listening for a lifetime.

We Want You Listening For A Lifetime

Used wisely, your new sound equipment will provide a lifetime of fun and enjoyment. Since hearing damage from loud noise is often undetectable until it is too late, this manufacturer and the Electronic Industries Association's Consumer Electronics Group recommend you avoid prolonged exposure to excessive noise. This list of sound levels is included for your protection.

<u>Decible Level</u>	<u>Example</u>
30	Quiet library, soft whispers
40	Living room, refrigerator, bedroom away from traffic
50	Light traffic, normal conversation, quiet office
60	Air conditioner at 20 feet, sewing machine
70	Vacuum cleaner, hair dryer, noisy restaurant
80	Average city traffic, garbage disposals, alarm clock at two feet.

THE FOLLOWING NOISES CAN BE DANGEROUS UNDER CONSTANT EXPOSURE

90	Subway, motorcycle, truck traffic, lawn mower
100	Garbage truck, chain saw, pneumatic drill
120	Rock band concert in front of speakers, thunderclap
140	Gunshot blast, jet plane
180	Rocket launching pad

Information courtesy of the Deafness Research Foundation.

Power supplies

The unit can be powered from batteries, household power supply, car battery, etc. If batteries are used, they should be alkaline batteries or rechargeable batteries. Manganese batteries are not suitable for operating this unit, because their capacity is too small to be used.

After switching the power OFF, the batteries are slightly consumed to hold the memory functions.

When the unit is not used for a long time (a week or more), remove the batteries from the unit.

■ Operation on household power supply

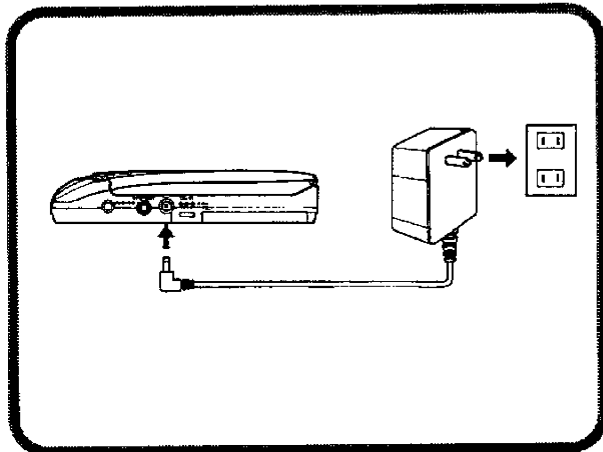

Caution in use of AC adapter:

1. Never use other AC adapter than that supplied with this unit.
2. When the unit is not to be used, unplug the AC adapter from the power outlet.
3. The supplied AC adapter is for domestic use only. Never use it in other countries.

■ Operation on alkaline batteries

When the unit is to be powered from batteries, use "LR6" alkali batteries. They make about three hours of playback possible under normal temperatures.

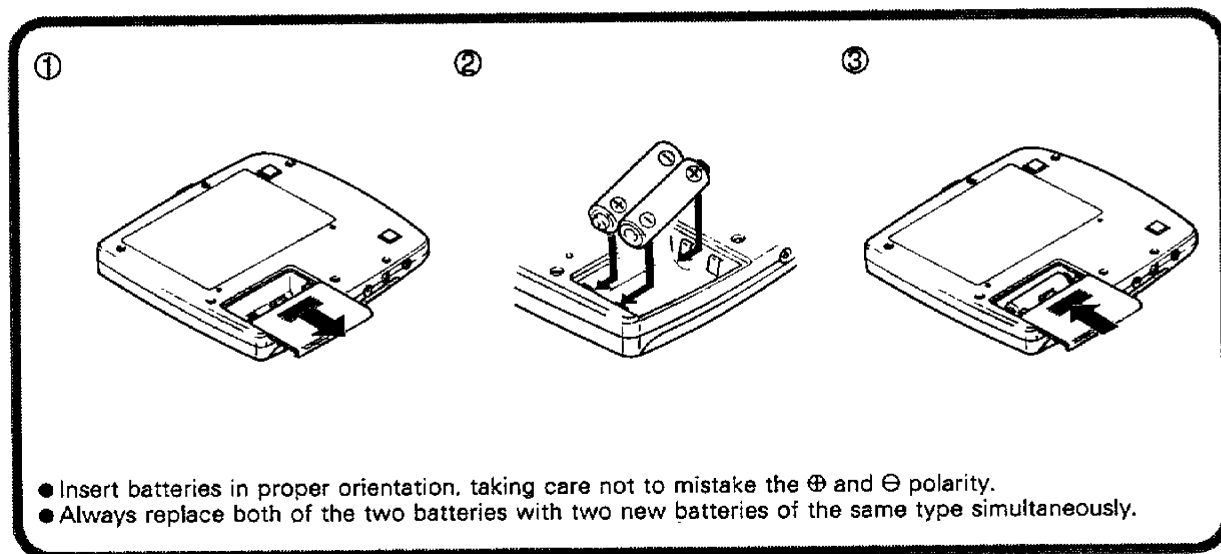

- Insert batteries in proper orientation, taking care not to mistake the \oplus and \ominus polarity.
- Always replace both of the two batteries with two new batteries of the same type simultaneously.

■ Operation on rechargeable batteries

Be sure to recharge the batteries when they are used for the first time, when they have not been used for a long period or when the battery indicator is blinking. It takes about two hours until the fully charged condition, and about two hours of playback is possible from this condition under normal temperatures. Be sure to use the exclusive (NB-77) rechargeable batteries. Other models of rechargeable batteries cannot be recharged.

1 Insert rechargeable batteries taking care of the correct polarity.

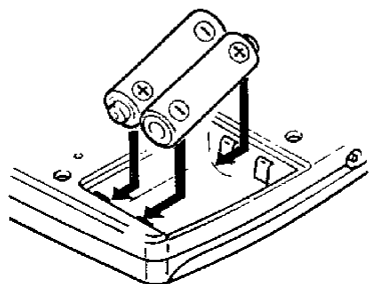

- Insert them taking care not to mistake the orientations of the ⊕ and ⊖ poles.
- Batteries cannot be recharged during playback. Turn the power OFF before recharging them.
- A rechargeable battery can be recharged about 500 times. When the operable period shortens, please purchase new optional rechargeable batteries (NB-77).

2 Start recharging.

- ① Check that the power is in the OFF condition.
- ② Connect the AC adaptor.
- ③ Press the AI AUTO/CHARGE key.

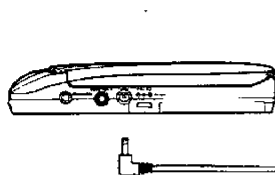

During recharging

Lights up.

After recharging
(Returns to OFF.)

Goes off.

④ After charging, disconnect the AC adaptor from the unit.

- Five seconds after connecting the AC adaptor, press the **AI AUTO/CHARGE** key.
- Be sure to shut the cover of the unit during recharging.

Note:

As an inherent characteristic of rechargeable batteries, the charging capacity drops if a battery is recharged several times while the charge remaining in it is large. In such a case, the original charging capacity can be recovered gradually by recharging it only after the charge has been exhausted completely several times.

Controls and indicators

■ Main unit

Front panel When the power is supplied through the AC adapter or car battery adapter, the keys and display marked * are illuminated by the internal back lights (DPC-721 and DPC-521 only).

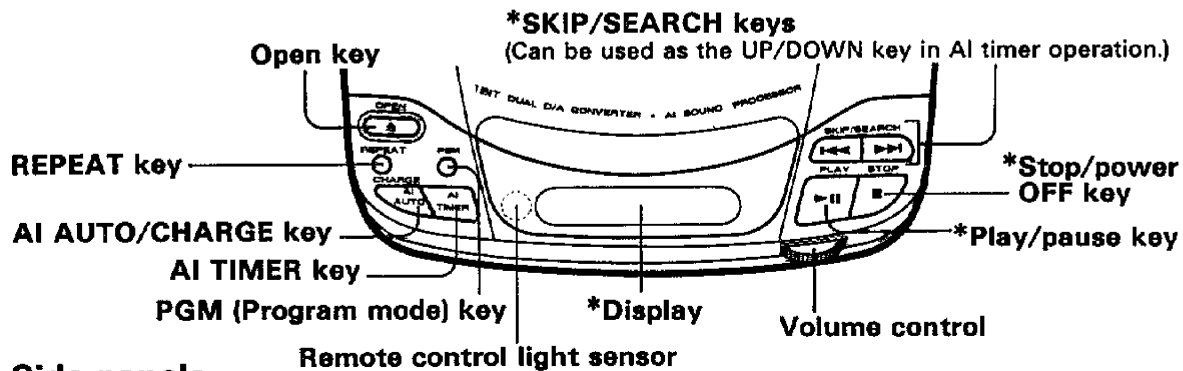

Side panels

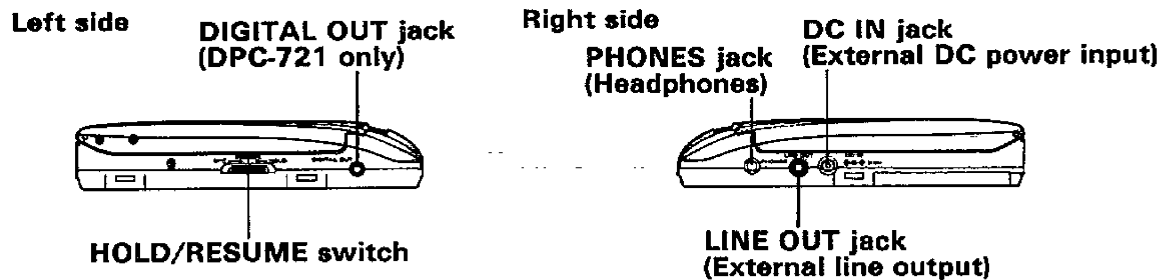

Main panel display

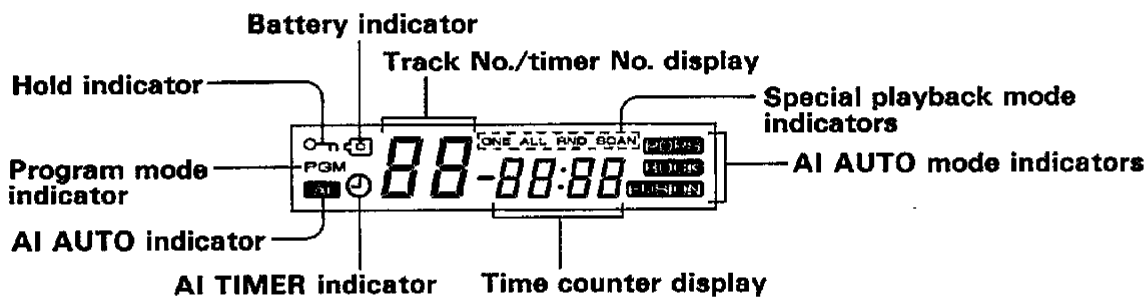

■ Micro-headphones with remote controller (DPC-321 for the U.S.A. only)

The keys with the same names as the keys on the main unit have the same functions as them.

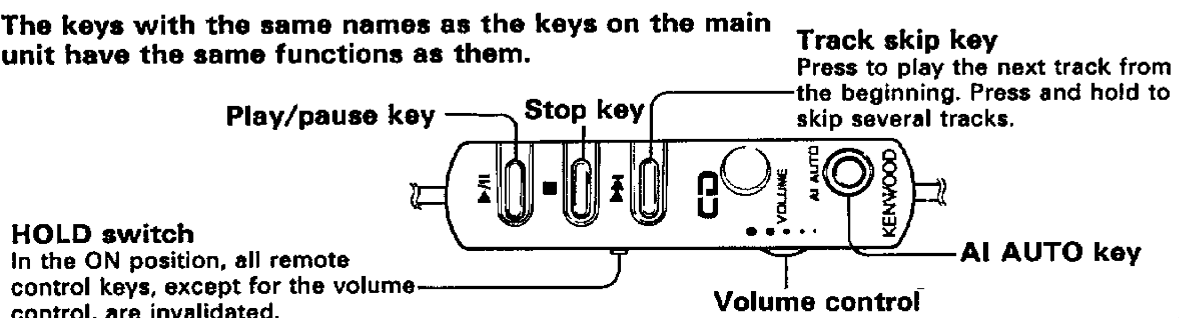

■ Card remote control unit (DPC-721 and DPC-521 only)

The card remote control is not available when the unit is powered by batteries.

The keys with the same names as the keys on the main unit have the same functions as them.

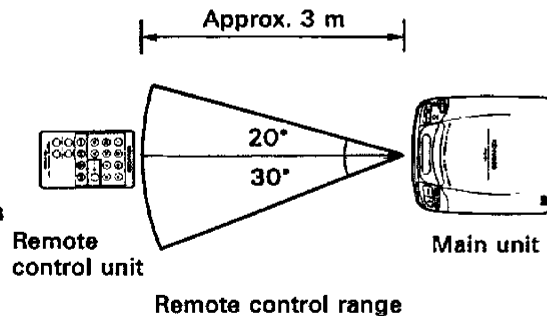
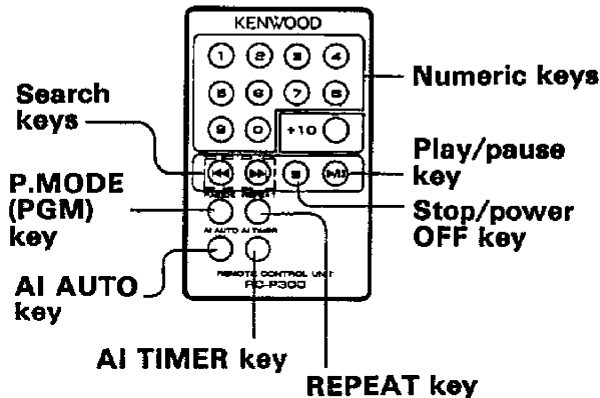

- Before use, pull out the battery protection sheet from the rear panel.
- When pressing the operation keys on the remote control unit, reserve an interval of 1 second or more between each press. The remote control operation may be difficult if direct sunlight is incident to the main unit.
- When replacing the battery, use a lithium battery (CR2025) available in audio stores.

Note:

Malfunction may occur if direct sunlight or the light of a high-frequency lighting fluorescent lamp enters the remote control light sensor. In such a case, change the system installation position to prevent the malfunction.

■ LCD display remote control unit

(Optional with DPC-521 (except some areas), not usable with DPC-321)

The keys with the same names as the keys on the main unit have the same functions as them.

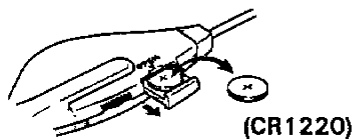
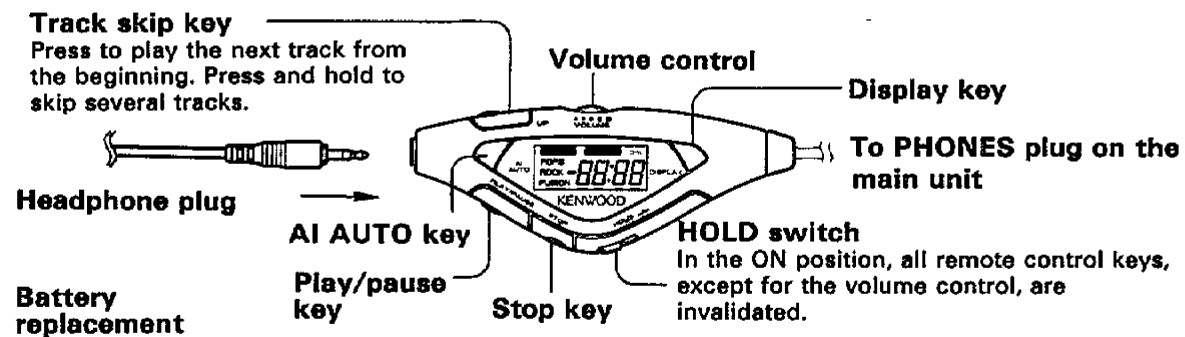

*IMPORTANT

This option may not be available in some areas. For details on options, consult your dealer.

- If the plug is inserted or removed during playback, the LCD display content may differ from the actual main unit status. To reset, tune the power OFF.

Preparation for playback

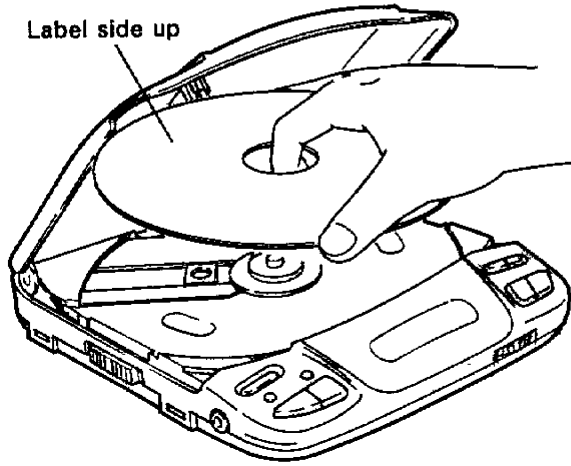

■ Connecting headphones

PHONES LINE OUT DC IN 5.0V

Headphones plug

- Use headphones equipped with a stereo mini-plug.

■ Placing the disc

1 Open the cover.

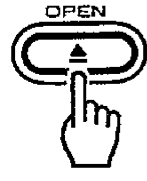

2 Place a disc.

- Hold it with the label side up and align with the center pin.

3 Close the cover.

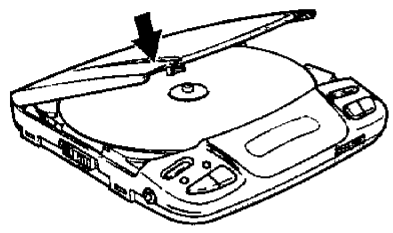

- Press down the left front side of the cover until it locks in place with a click.

Basic operation

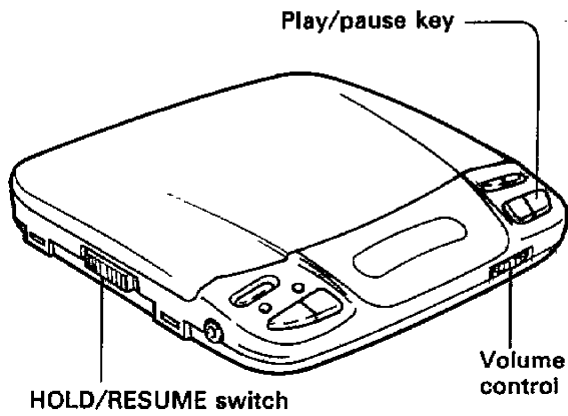

Before operation

Be sure to set the HOLD/RESUME switch to the OFF or RESUME position before operation.

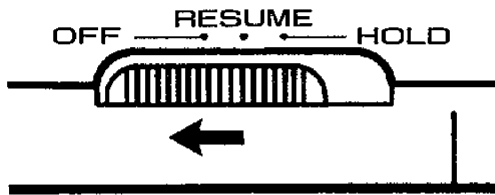

● For the HOLD/RESUME switch, refer to page 23.

Normal playback

1 Start playback.

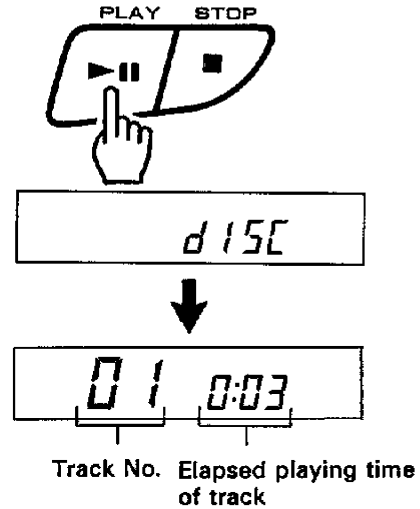

● Playback starts.

2 Adjust the volume.

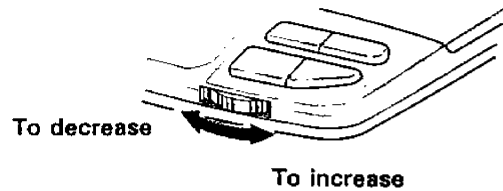

● Adjust the volume control on the remote control unit accordingly when using the LCD display remote control unit (RC-P500) or micro-headphones with remote controller (KH-R300).

Basic operation

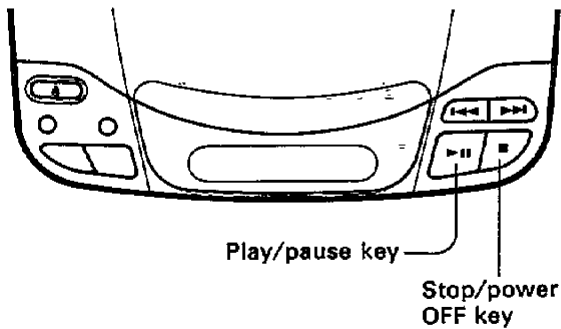

Pausing playback

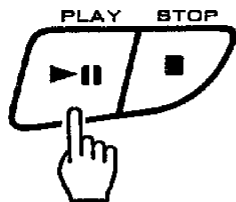

Blinks.

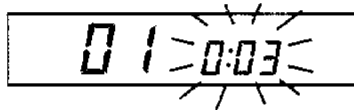

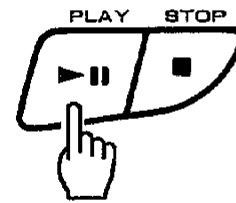

- Press again to resume playback.

To stop playback



- The total number of tracks and the total playing time of disc are displayed.
- When the HOLD/RESUME switch is in the RESUME position, the track number and time where playback was stopped are displayed.

To enter stop mode:

Programmed playback and AI timer settings can be made only in the stop mode. To enter stop mode from the power OFF condition, press the  key and, when the track No. is displayed, press the  key.

To turn the power OFF

First enter the stop mode, then press the  key for the second time.

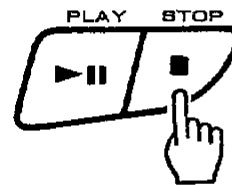

Auto power-OFF function

If no operation key has been pressed for more than 3 minutes in the stop mode, the power is turned OFF automatically to prevent battery power consumption. (The programmed playback mode is not canceled by this.)

Starting playback from the desired track

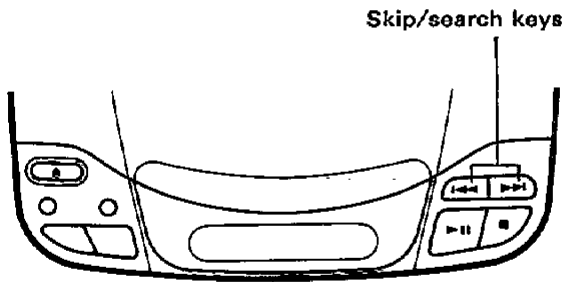

Track search

Tap lightly the search key corresponding to the direction you want to skip.

To skip backward

To skip forward



- The same number of tracks as the number of times the key is tapped are skipped.
- When the key is tapped once during playback, the track being played will be replayed from the beginning.

Direct track search

A track can be searched directly by using the numeric keys on the card remote control unit (RC-P300). (DPC-721 and DPC-521 only)

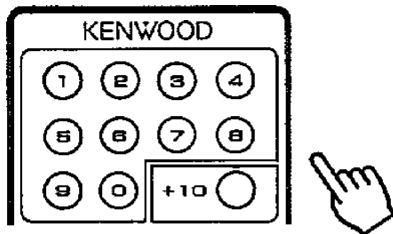

(Examples)

To search track No. 23,
Press twice then press .

To search track No. 30,
Press three times then press .

Fast forward or fast backward search

Press and hold the search key corresponding to the direction you want to search.

Fast forward search

Fast backward search



- Normal playback resumes from the position you release the key.

Programmed playback

Before programming, be sure to set the CD player in the stop mode (refer to page 14).

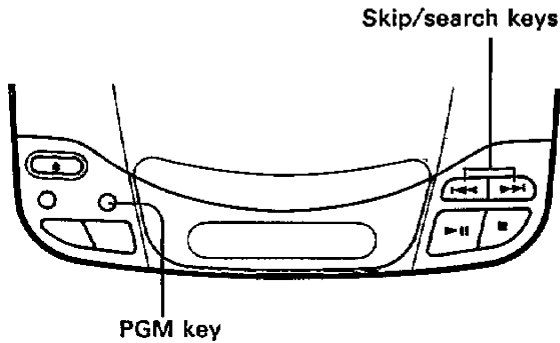

Before programmed playback

Be sure to set the HOLD/RESUME switch to the RESUME or OFF position.

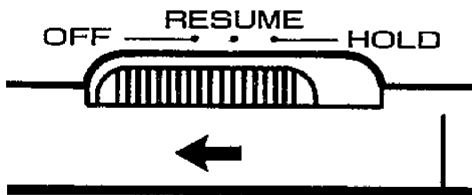

Programmed playback procedure

1 Enter the stop mode.

2 Initiate the program mode.
Press the PGM key.

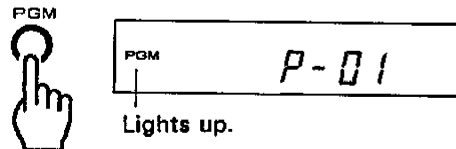

3 Program desired tracks in the desired order.

① Select a track.

To select track No. 3 as program No. 1:

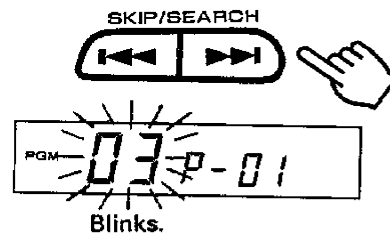

- The track can also be selected with the numeric keys on the card remote control unit. (DPC-721 and DPC-521 only)

② Program it.

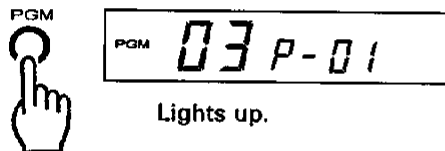

- Program other desired tracks by repeating steps ① and ② for each track.
- Up to 20 tracks can be programmed.

4 Start playback.

Press the  key.

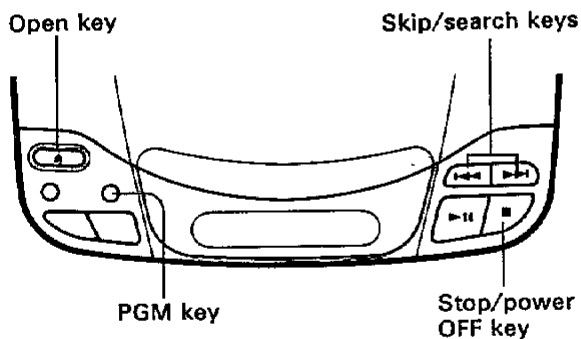

■ Modifying the program contents

1 Enter the stop mode.

2 Recall the track No. to be changed.

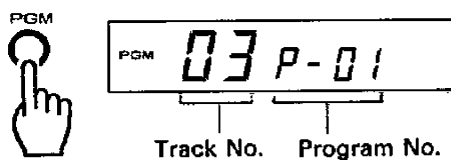

- Press the key repeatedly until the track number to be changed is displayed.

3 Select the new track number to be programmed in place of the previous track number.

① Select the track. ② Program it.



- The track can also be selected with the numeric keys on the card remote control unit. (This function is not available with the DPC-321).

■ Checking the program contents

1 Enter the stop mode.

2 Press the PGM key.



- Every time the key is pressed, the track numbers are displayed in the order they are programmed.

■ Canceling the program

1 Enter the stop mode.

2 Press the  key or  key.

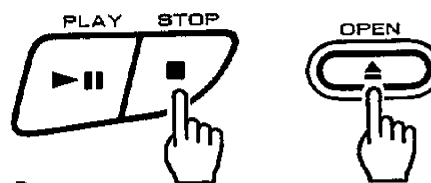

Press once.

or

Special playback operations

Various playback operations are available by pressing the REPEAT key in the play mode or stop mode.

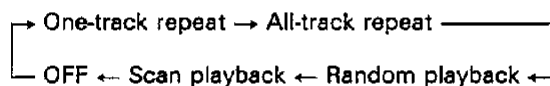

Each press switches over the play modes.

REPEAT

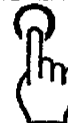

Press once	One-track repeat (ONE) The track being played or a selected track will be played repeatedly.	Lights up.
Press twice	All-track repeat (ALL) All tracks on the disc will be played repeatedly.	
Press 3 times	Random playback (RND) All tracks on the disc or all tracks in the program will be played in a random order. <ul style="list-style-type: none"> ● As the tracks are selected at random order, the same track may be played. ● If the random playback mode is initiated during normal playback, the random playback starts after the track being played has completed. 	
Press 4 times	Scan playback (SCAN) A part of every track on the disc will be played for 20 seconds each. <ul style="list-style-type: none"> ● If the scan playback mode is initiated during normal playback, scan playback starts after the track being played has completed. ● With track No. 44 and later, the first 20 seconds of the tracks will be played in sequence. 	
Press 5 times	Cancellation Normal playback mode resumes.	Goes off.

AI TIMER operations

Three kinds of timer playback operations are possible within the same timer period as the total playing time of the disc in the unit.

AI TIMER 1 (Sleep timer)

The playback volume starts to decrease gradually like fade-out at 5 seconds before the set timer period expires, stops at the end of the set timer period, and the power is turned OFF in 3 minutes after it. This function can be used as the sleep timer.



AI TIMER 2 (Wake-up timer)

Normal playback continues at a low volume until 5 seconds before the set timer period expires, then the volume starts to increase gradually like fade-in, and returns to the original volume at the end of the set timer period. This function can be used as a wake-up timer when you are going to sleep for a short period, for example in a train.

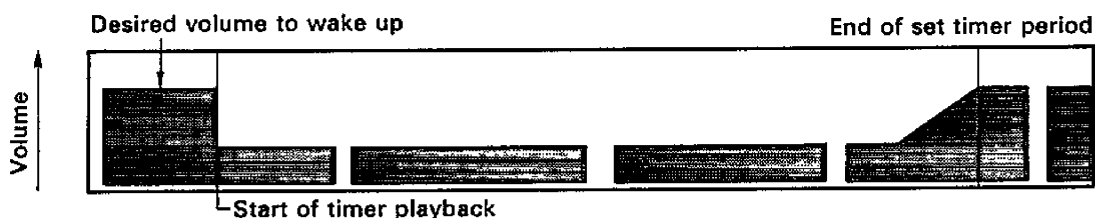

- Also set the volume you want to wake up to before starting the timer playback.

AI TIMER 3 (Disc timer)

By fading out every track at proper timing, all tracks on the disc will complete to be played at the moment the set timer period expires.

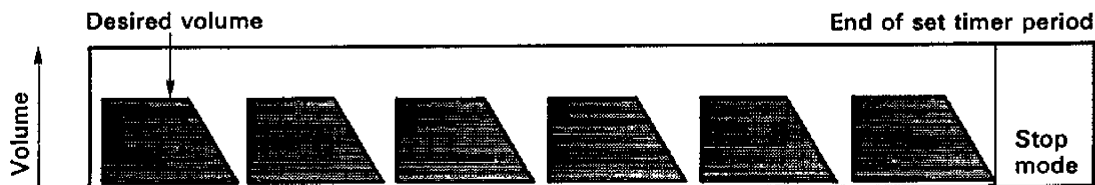

- If there are large number of tracks and the set timer period is short, all tracks may not be able to be played.

AI TIMER playback procedure

AI TIMER playback can be started only from the stop mode.
AI TIMER playback cannot be used in the programmed playback mode.

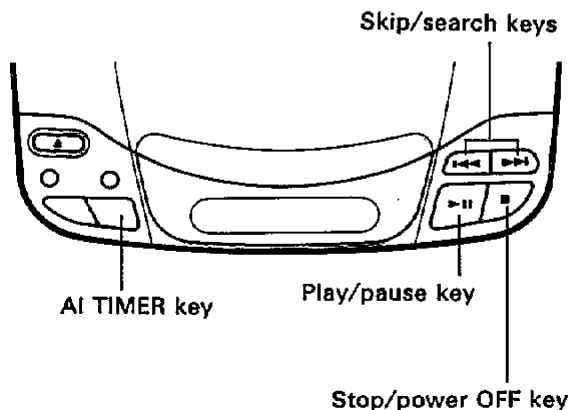

1 Select the timer mode.

The timer modes are switched every time the key is pressed.

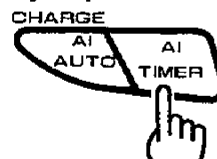

- With AI TIMER 2, first set the volume you want to wake up to before the above.

The timer number and the total playing time of disc (in minutes) are displayed.

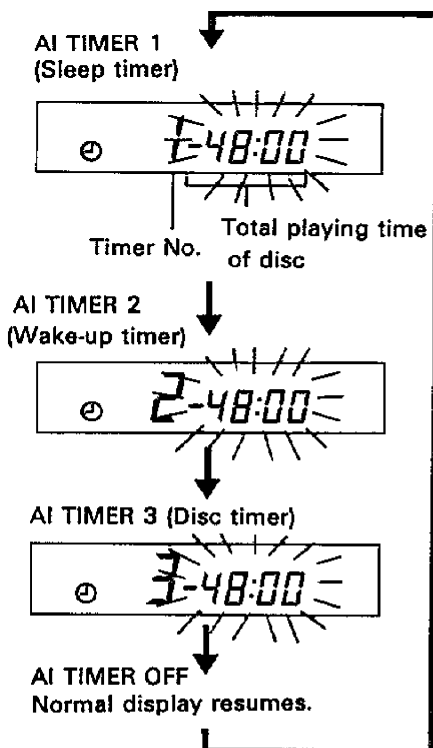

- When setting more than one timer, the time of the previously set timer is displayed when setting the next timer.

2 Set the desired timer period.

Specify the timer period (in minutes) with the search keys.

To set the timer period of AI TIMER 1 to 20 minutes:



- Each press of the key allows to increment or decrement the time setting by one minute.

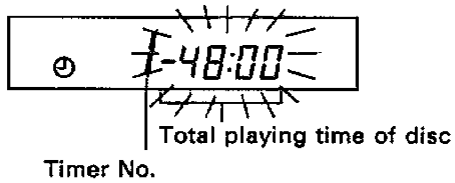

- Set the timer period within about 5 seconds after the start of blinking.

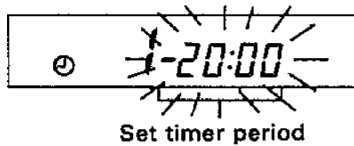

- It is not possible to set a longer timer period than the total playing time of the disc.
- Perform step 3 within 5 seconds after setting the desired time.
- In case of AI TIMER 2 or AI TIMER 3 operation, set the desired timer period in the same procedure as above.

3 Start playback.

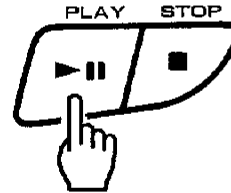

- AI TIMER play starts.

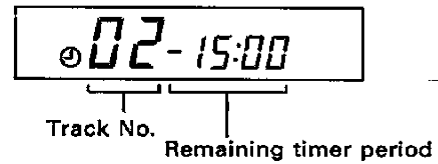

To check the current timer No.

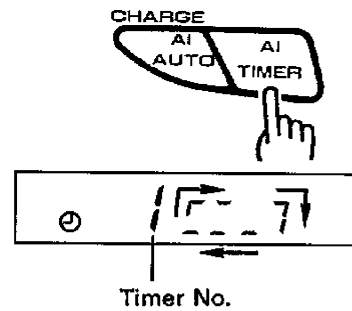

To cancel:

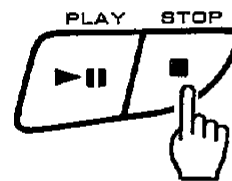

Press once.

- Pressing the OPEN key erases all setting contents.

AI Sound processor

This unit incorporates three preset equalizer curves, POPS, ROCK and FUSION, to allow enjoy music of various categories. When AI AUTO position has been set, the unit samples the disc to be played and selects the optimum equalizer curve automatically. Please select the equalizer curve in your desired way.

■ AI AUTO playback (setting)

1 Enter the stop mode.

2 Press the AI AUTO key.

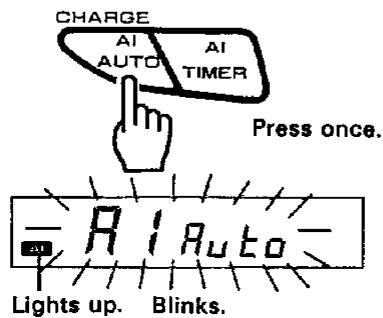

- Proceed to step 3 before the end of the 3 second period in which the above is displayed.

3 Press the play key.

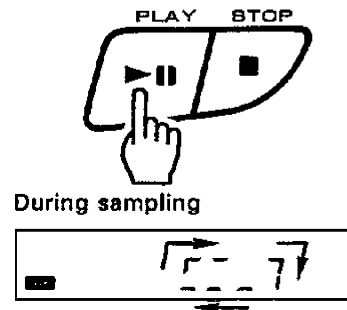

- The sound processor samples the disc automatically and select the optimum equalizer curve.

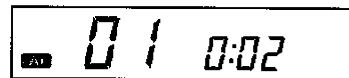

- Playback starts.

When AI AUTO key is pressed during playback

Every time the key is pressed, the preset equalizer curves are switched over as shown below.

① If AI AUTO setting has already been made:

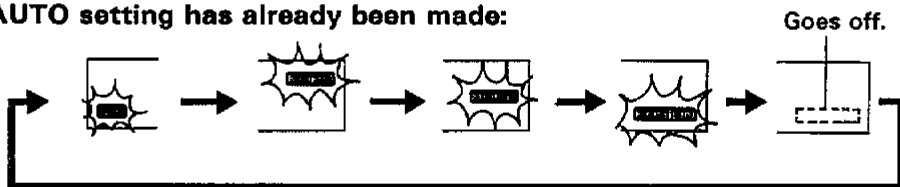

- The memory of the equalizer curve set by the AI AUTO function is cleared once the disc cover is opened.

② If AI AUTO setting has not been made:

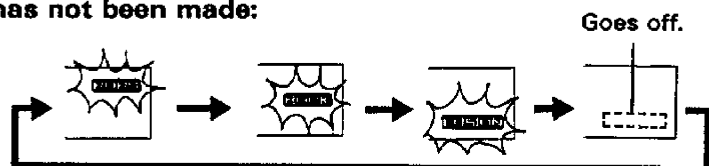

Note:

The effect of the AI sound processor is not applied to the LINE OUT output.

HOLD/RESUME switch

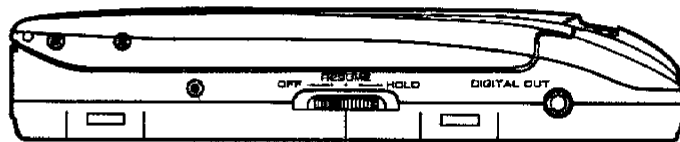

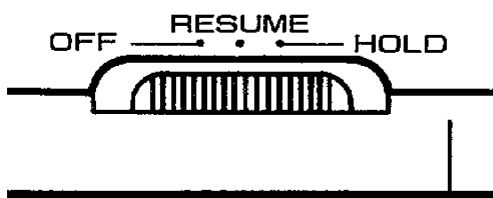

HOLD/RESUME switch



RESUME play

The playback can be resumed from the same position. This function is convenient in playback operation powered from the car battery adapter because the playback does not return to track No. 1 every time the power is switched OFF.

- To store the memory, be sure to insert the rechargeable batteries or alkaline batteries.
- In case more than one minute have passed, the disc playback is started from the beginning of the disc.
- If the cover is opened after having pressed the  key, the memory of the position where playback was stopped is cleared. When the  key is pressed in such a condition, playback starts from track No. 1 on the disc.

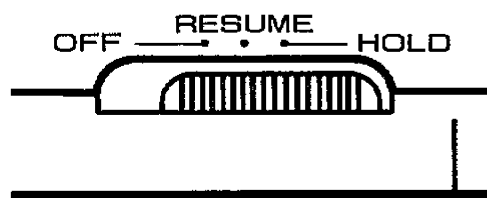

HOLD position

With the switch in the HOLD position, except for the  key and the volume. The RESUME function is kept activated in the HOLD position. This position is for use in prevention of erroneous operations when the unit is carried in a bag, etc.

Lights up.

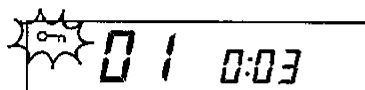

- To store the memory, be sure to insert the rechargeable batteries or alkaline batteries.
- Before operation, be sure to set the switch to other position than HOLD. Operation will not be possible unless the HOLD position is canceled.

Listening through car stereo

■ Connections

Plug the car battery adapter (DC-C3) into the cigar lighter socket.
Insert the car cassette adapter (CAC-1) into the cassette slot of the car stereo.

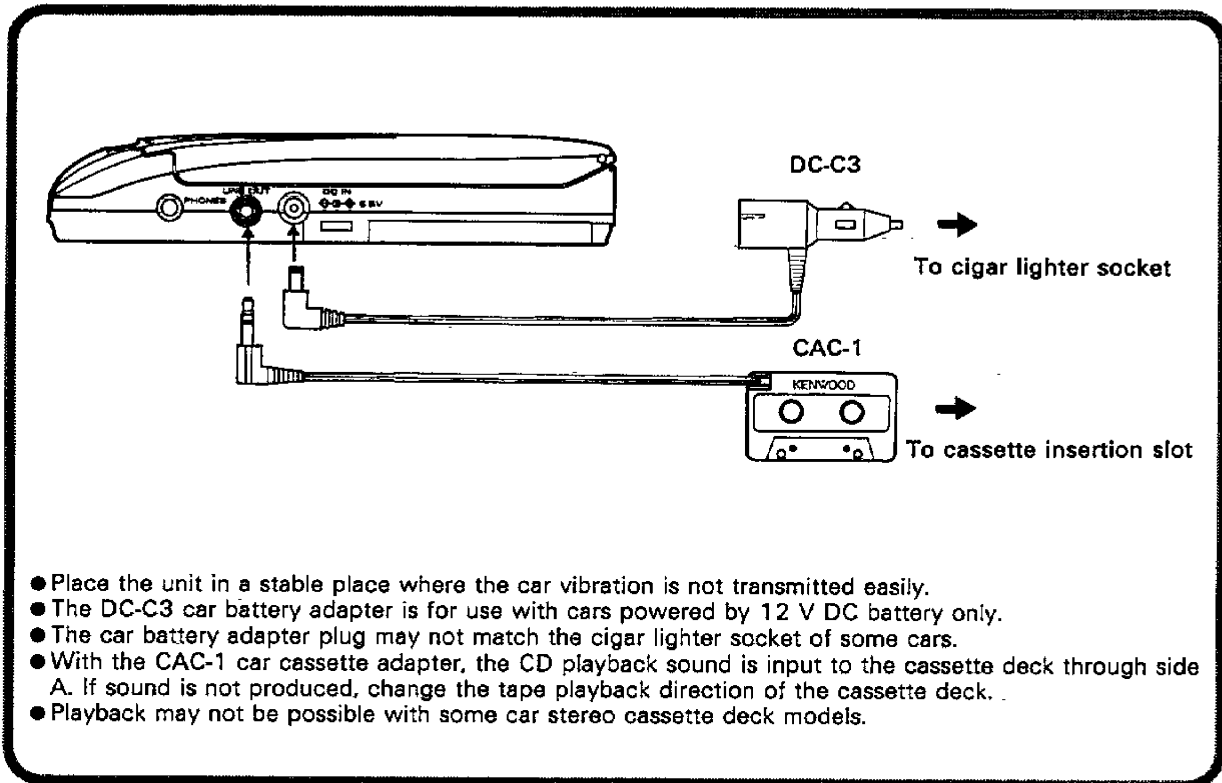

Notes:

1. If playback is not possible when the car battery adapter is connected, there is a possibility that the fuse has blown. In this case, turn the electrode on the tip counterclockwise and replace the fuse. Use a fuse rated at 2 A.
2. Do not leave the main unit, remote control unit or batteries in the car, especially on the dashboard. This may lead to malfunction due to the heat of solar light.

In case abnormality, such as smoke is observed, immediately unplug the car battery adapter from the cigar lighter.

*IMPORTANT

This option may not be available in some areas. For details on options, consult your dealer.

Listening through audio system

The unit can be connected to and played through a home audio system.

Analog connection

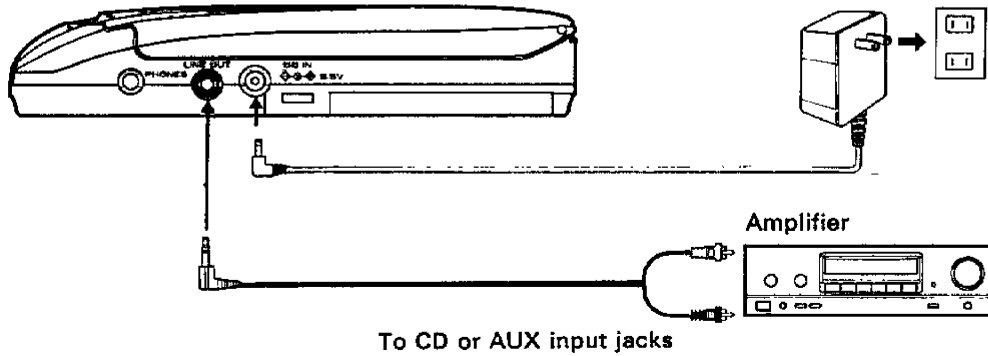

Digital connection (DPC-721 only)

For digital connection, remove the protection cap from the digital output jack.

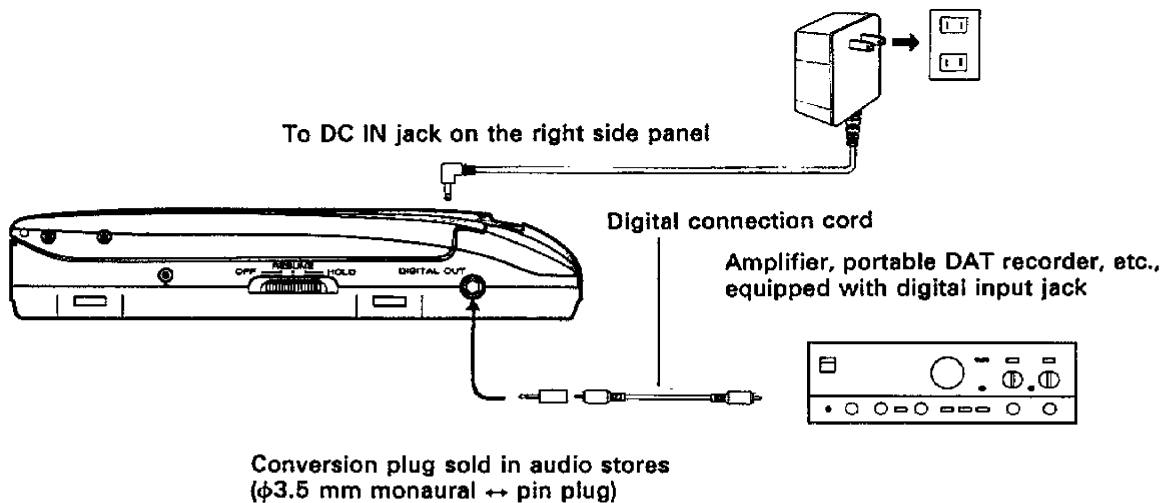

● Also connect the AC adapter in the same way as the analog connection.

Notes:

1. Be sure to turn the power of the amplifier, etc., OFF before connection.
2. The playback volume is to be adjusted on the amplifier.

In case of difficulty

What seems to be a serious trouble is often due to simple mistake. In case of trouble, check it again by referring to the table below.

Note that servicing may be charged if it is requested based on the following symptoms.

Symptom	Cause	Remedy
Operation does not occur when an operation key is pressed.	<ul style="list-style-type: none">● The HOLD/RESUME switch on the main unit or remote control unit is in the HOLD position.● The batteries are exhausted.● The disc is placed upside down.● Dew is condensed inside the unit.● The AC adapter is disconnected.	<ul style="list-style-type: none">● Set to other position than HOLD.● Replace both of the two alkaline batteries, or recharge the rechargeable batteries.● Place the disc with the label side facing upward.● Leave the unit for about an hour before use.● Connect it properly.
No sound is output through headphones.	<ul style="list-style-type: none">● The headphones plug is connected incompletely.● The volume control of the main unit or remote control unit is set in a low position.	<ul style="list-style-type: none">● Insert it securely into the PHONES jack.● Adjust the volume control of the main unit or remote control unit.
Sound skips or interrupts.	<ul style="list-style-type: none">● The unit is used in a place subject to large vibrations.● The disc is dirty.● The internal lens is dirty.● The headphones plug is dirty.● The batteries are exhausted.	<ul style="list-style-type: none">● Place the unit in a place subject to small vibrations.● Clean it.● Clean it.● Clean it.● Recharge or replace them.

Notes:

1. This system is microprocessor-controlled, so malfunction may occur due to external noise or interference noise. In such a case, unplug the power cord, plug it and turn power on again.
2. Do not use contact cleaners because it could cause a malfunction. Be specially careful against contact cleaners containing oil, for they may deform the plastic components.

Specifications

Format

System Compact disc digital audio system
Laser Semiconductor laser

Audio

Frequency response 20 Hz ~ 20 kHz, ± 3 dB
Signal to noise ratio More than 100 dB (1 kHz)
Output level/impedance ($\phi 3.5$ mm stereo mini)
Fixed 0.75 V/1.2 k Ω
Digital output ($\phi 3.5$ mm monaural mini) (DPC-721)
Coaxial 0.5 V_{p-p}/75 Ω
Headphone output ($\phi 3.5$ mm stereo mini) 10 mW + 10 mW (16 Ω , 1 kHz)

General

Power supply
External power DC 5.5 V
Battery power DC 3 V
Battery life Approx. 3 hours
(continuous repeat playback with alkaline batteries)
Approx. 2 hours
(continuous repeat playback with rechargeable batteries)
Dimensions W: 127 mm
H : 28 mm
D : 143 mm
Weight (Net) 270 g

Note:

KENWOOD follows a policy of continuous advancements in development. For this reason specifications may be changed without notice.

For the U.S.A.

CAUTION:

Use of controls or adjustments or performance of procedures other than those specified herein may result in hazardous radiation exposure.

In compliance with Federal Regulations, following are reproductions of labels on, or inside the product relating to laser product safety.

KENWOOD CORPORATION
SHIONOGI SHIBUYA BUILDING 17-5,
2-CHOME, SHIBUYA, SHIBUYA-KU,
TOKYO, JAPAN

KENWOOD CORP. CERTIFIES THIS EQUIPMENT
CONFORMS TO DHHS REGULATIONS NO. 21 CFR
1040.10, CHAPTER I, SUBCHAPTER J.

Location: Bottom Panel

**For the U.S.A.
FCC WARNING:**

This equipment may generate or use radio frequency energy. Changes or modifications to this equipment may cause harmful interference unless the modifications are expressly approved in the instruction manual. The user could lose the authority to operate this equipment if an unauthorized change or modification is made.

NOTE:

This equipment has been tested and found to comply with the limits for a CLASS B digital device, pursuant to Part 15 of the FCC Rules. These limits are designed to provide reasonable protection against harmful interference in a residential installation. This equipment may cause harmful interference to radio communications, if it is not installed and used in accordance with the instructions. However, there is no guarantee that interference will not occur in a particular installation. If this equipment does cause harmful interference to radio or television reception, which can be determined by turning the equipment off and on, the user is encouraged to try to correct the interference by one or more of the following measures:

- Reorient or relocate the receiving antenna.
- Increase the separation between the equipment and receiver.
- Connect the equipment into an outlet on a circuit different from that to which the receiver is connected.
- Consult the dealer or an experienced radio/TV technician for help.

**For CANADA
DOC REGULATION**

"This digital apparatus does not exceed the CLASS B limits for radio noise emissions from digital apparatus as set out in the radio interference regulations of the Canadian Department of Communications."

CAUTION

Danger of explosion if battery is incorrectly replaced. Replace only with the same or equivalent type recommended by the equipment manufacturer. Discard used batteries according to manufacturer's instructions.

VARNING

Explosionsfara vid felaktigt batteribyte. Använd samma batterityp eller en ekvivalent typ som rekommenderas av apparattillverkaren. Kassera använt batteri enligt fabrikantens instruktion.

ADVARSEL!

Lithiumbatteri-Eksplosionsfare ved fejlagtig håndtering. Udskiftning må kun ske med batteri af samme fabrikat og type. Levér det brugte batteri tilbage til leverandøren.

VAROITUS

Paristo voi räjähtää, jos se on virheellisesti asennettu. Vaihda paristo ainoastaan laitevalmistajan suosittelemaan tyyppiin. Hävitä käytetty paristo valmistajan ohjeiden mukaisesti.

ADVARSEL

Lithiumbatteri-Eksplosjonsfare. Ved utskifting benyttes kun batteri som anbefalt av apparatfabrikanten. Brukt batteri returneres apparatleverandøren.